

OPERATION AND INSTALLATION MANUAL

TANK-TYPE WATER HEATERS FOR VERTICAL MOUNTING **4 kW/400 V**

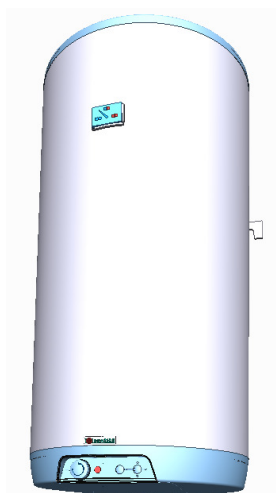

Combined

OKC 80
OKC 100
OKC 125
OKC 160
OKC 180
OKC 200

OKC 100/1m²
OKC 125/1m²
OKC 160/1m²
OKC 180/1m²
OKC 200/1m²

Electric

OKCE 80
OKCE 100
OKCE 125
OKCE 160
OKCE 180
OKCE 200

Družstevní závody Dražice - strojírna s.r.o.
Dražice 69, 294 71 Benátky nad Jizerou
tel.: +420 / 326 370 990
fax: +420 / 326 370 980
e-mail: prodej@dzd.cz



CONTENTS

1	TECHNICAL SPECIFICATION OF PRODUCT	4
1.1	FUNCTION DESCRIPTION	4
1.2	ADVICE FOR CUSTOMERS	5
1.2.1	HOT WATER CONSUMPTION	5
1.2.2	ENERGY SAVING.....	5
1.2.3	EMERGENCY POWER CONSUMPTION	5
1.3	DESIGN AND GENERAL HEATER DIMENSIONS.....	6
2	OPERATION AND FITTING INSTRUCTIONS.....	11
2.1	OPERATING CONDITIONS	11
2.2	WALL MOUNTING.....	11
2.3	PLUMBING FIXTURE.....	12
2.4	ELECTRIC WIRING	14
2.4.1	ELECTRIC INSTALLATION GENERAL INFORMATION.....	14
2.5	CONNECTION OF INDIRECT HEATER TO HOT WATER HEATING SYSTEM	15
2.6	FIRST HEATER COMMISSIONING	16
2.7	PUTTING OUT OF SERVICE, DISCHARGE	16
2.8	INSPECTION, MAINTENANCE & CARE FOR THE APPLIANCE	17
2.9	MOST FREQUENT FUNCTION FAILURES AND THEIR CAUSES	18
3.	OPERATION OF THERMOSTAT	19
3.1	OPERATING MODES.....	19
3.1.1	SERVICING.....	19
3.1.2	TEMPERATURE SETTING	19
3.1.3	LIMITING THE REGULATION RANGE; LOCKED SETTINGS.....	20
4	IMPORTANT NOTICES	20
4.1	INSTALLATION REGULATIONS.....	20
4.2	DISPOSAL OF PACKAGING MATERIAL AND FUNCTIONLESS PRODUCT	21
3	PRODUCT ACCESSORIES	21

READ CAREFULLY THE BELOW INSTRUCTIONS PRIOR TO THE INSTALLATION THE HEATER!

Dear Customer,

The Works Cooperative of Dražice – Machine Plant, Ltd., would like to thank you for your decision to use a product of our brand. With this guide, we will introduce you to the use, construction, maintenance and other information on electrical water heaters.



The manufacturer reserves the right for engineering modification of the product. The product is designed for permanent contact with drinkable water.

It is recommended to use the product in indoor environment with air temperatures from +2°C to 45°C and a relative humidity up to 80%.

Product's reliability and safety is proven by tests implemented by the Engineering Test Institute in Brno.

Meaning of pictograms used in Manual



Important information for heater users.



Recommendations of manufacturer, observance of which will ensure trouble-free operation and long service life of the product.



CAUTION!

Important notice to be observed.

1 TECHNICAL SPECIFICATION OF PRODUCT

1.1 FUNCTION DESCRIPTION

The heater is designed for accumulation heating of service water using electricity or thermal energy via an exchanger (for the combined design only). **Water is heated by an electric element (or a heat exchanger)** in an enamelled thermally insulated accumulator at the time defined by the power supplier. The element is at the time of heating controlled by a thermostat the temperature of which can be adjusted continuously (within the range between 5°C and 74°C). Once the selected temperature is reached, heating interrupts automatically. **Water accumulated in the tank is then used for consumption.** The tank keeps constant pressure of water from the water main. If the combination faucet hot water valve is opened, water from the water supply conduit pressed out by cold water pressure flows out of the heater. Hot water flows out through the top part, and water flowing in remains in the bottom part of the heater. Pressure principle allows hot water withdrawal at any place from the heater.

a) *Water heating by electric energy*

After the heater is connected to electric network, the heating element starts heating water. The element is turned on and off by a thermostat. After reaching the temperature set, the thermostat switches off the electric circuit and thus discontinues water heating. The control light signals if the element is in operation (light is on) or if it is off (the light goes out). In case of longer operation without using the heated volume, the thermostat has to be set to position 5°C to 8°C (set the “snowflake” symbol on the thermostat selector) to avoid its freezing, or electricity supply to the heater has to be switched off. In combined versions, the stop valve on the inlet to the exchanger has to be closed, which prevents heating water in the hot water heating system.

b) *Service water heating via thermal energy through heat exchanger*

Closing valves of the heat exchanger must be opened which ensures heating water flow from the hot water heating system. Together with a closing valve, it is recommended to install an air outlet valve at the inlet to the heat exchanger in order to bleed the heat exchanger as needed, in particular before the beginning of the heating season. The time of heating using the heat exchanger depends on the temperature and flow of water in the hot water heating system. A combined heater is made in universal design – depending on the need of connecting the closing valves to the heating element either from the right, or from the left.

1.2 ADVICE FOR CUSTOMERS

1.2.1 HOT WATER CONSUMPTION



Consumption of hot water in households depends on the number of people, amount of sanitary equipment, length, diameter and insulation of piping in the flat, or on individual habits of users. The cheapest option of water heating comes at the time when the electricity rate is reduced.



Find out in what time intervals your electricity supplier provides reduced tariff and, depending on that information, select relevant volume and power input of the heater so that your hot water consumption covered the needs of your household.

1.2.2 ENERGY SAVING



Adjust the temperature of the heater's thermostat to that level only that you need to run your home. Thus you will reduce electricity consumption, as well as the amount of lime sediments on the walls of the receptacle and on the electric element's pit.

1.2.3 EMERGENCY POWER CONSUMPTION



If no heated water is taken from the tank, a small amount of heat leaks. This loss is measured for a period of 24 hours at the temperature of 65°C in the heater, and at 20°C in its ambient area. The resulting value is expressed in [kWh/24h] and indicates the amount of power needed to maintain the set temperature.

Data Sheet pursuant to Directive No - see Table 1.

HEATER TYPES	ENERGY EFFICIENCY CLASS	HEAT LOSSES (kWh/24hr/l)	NOMINAL CAPACITY (l)	TIME OF CONTENT HEATING (hours)	ELECTRICITY CONSUMPTION FOR HEATING OF THE CONTENTS FROM 15°C TO 65°C (kWh)	HEAT LOSSES (kWh/24h)
OKC 80	C	8.9	75	1.1	4.8	0.71
OKC 100; OKC 100/1m ²	C	8.8	95	1.5	6	0.88
OKC 125; OKC 125/1m ²	C	8.7	120	2	8	1.09
OKC 160; OKC 160/1m ²	C	8.7	147	2.4	9.6	1.33
OKC 180; OKC 180/1m ²	C	7.7	175	2.7	10.6	1.39
OKC 200; OKC 200/1m ²	B	7	195	3	12	1.4
OKCE 80	C	8.9	80	1.1	4.8	0.71
OKCE 100	C	8.8	100	1.5	6	0.88
OKCE 125	C	8.7	125	2	8	1.09
OKCE 160	C	8.7	152	2.4	9.5	1.33
OKCE 180	C	7.7	180	2.7	10.6	1.39
OKCE 200	B	7	200	3	12	1.4

Table 1

1.3 DESIGN AND GENERAL HEATER DIMENSIONS

The heater receptacle is made of a steel plate and tested by 0.9 MPa overpressure. The inside of the receptacle is enamelled. A flange is welded onto the lower bottom of the receptacle with a flange lid screwed onto it. A sealing ring is inserted between the flange lid and the flange. Thermo wells for thermostat sensors and thermometer installation are placed in the flange lid. Anode rod is mounted on M8 nut. **The water reservoir is insulated by means of polyurethane foam.** Electric wiring is placed underneath

the plastic removable cover. The temperature of water can be set using the thermostat. Heat exchanger(s) is/are welded onto the pressure tank.

Description of basic parts of the heater – Figure 1, Figure 2. Heater dimensions – (Figure 1, Figure 2) and (Table 3, Table 4)

TYPE		OKC 80	OKC 100	OKC 125	OKC 160	OKC 180	OKC 200
			OKC 100/1m ²	OKC 125/1m ²	OKC 160/1m ²	OKC 180/1m ²	OKC 200/1m ²
		OKCE 80	OKCE 100	OKCE 125	OKCE 160	OKCE 180	OKCE 200
CAPACITY K / E	l	75/80	95/100	120/125	147/152	175/180	195/200
MAX. OPERATING OVERPRESSURE IN THE TANK	MPa	0.6					
MAXIMUM OPERATING OVERPRESSURE IN THE EXCHANGER*	MPa	1					
ELECTRIC CONNECTION	3 PE-N 400V/50Hz						
POWER INPUT	W	4000					
EL. PROTECTION	IP 45						
MAX TEMPERATURE OF HSW	°C	80					
RECOMMENDED HSW TEMPERATURE	°C	60					
HEIGHT OF THE HEATER	mm	736	881	1046	1235	1187	1287
DIAMETER OF THE HEATER	mm	524	524	524	524	584	584
MAX WEIGHT OF THE HEATER WITHOUT WATER	kg	42/36	52/58/ 42	58/64/ 48	66/72/ 58	76/82/ 72	81/88/ 76
TIME OF EL. HEATING FROM 10°C TO 60°C	hod	1.1	1.5	2	2.4	2.7	3
HEAT LOSSES/EN. CLASS	kWh/24h	0.71/C	0.88/C	1.09/C	1.33/C	1.39/C	1.4/B

TYPE		OKC 80	OKC 100	OKC 125	OKC 160	OKC 180	OKC 200
EXCHANGER HEAT SURFACE	m ²	0.41	0.68	0.68	0.68	0.68	0.68
RATED THERMAL OUTPUT AT HEATING WATER TEMPERATURE OF 80°C AND FLOW 720 l/h	W	9000	17000	17000	17000	17000	17000
TIME OF HEATING BY EXCHANGER FROM 10°C TO 60°C	min	32	23	28	35	40	45
RATED THERMAL OUTPUT AT HEATING WATER TEMPERATURE OF 80°C AND FLOW 310 l/h	W	7000	9000	9000	9000	9000	9000
TIME OF HEATING BY EXCHANGER FROM 10°C TO 60°C	min	50	48	55	75	77	86
TYPE			OKC 100/1m ²	OKC 125/1m ²	OKC 160/1m ²	OKC 180/1m ²	OKC 200/1m ²
EXCHANGER HEAT SURFACE	m ²	-	1.08	1.08	1.08	1.08	1.08
RATED THERMAL SURFACE AT HEATING WATER TEMPERATURE OF 80°C AND FLOW 720 l/h	W	-	24000	24000	24000	24000	24000
TIME OF HEATING BY EXCHANGER FROM 10°C TO 60°C	min	-	14	17	23	26	28

* The OKCE series heaters do not have a heat exchanger.

Table 2

**OKC 80, OKC 100, OKC 125, OKC 160, OKC 180, OKC 200,
OKC 100/1m², OKC 125/1m², OKC 160/1m², OKC 180/1m², OKC 200/1m²**

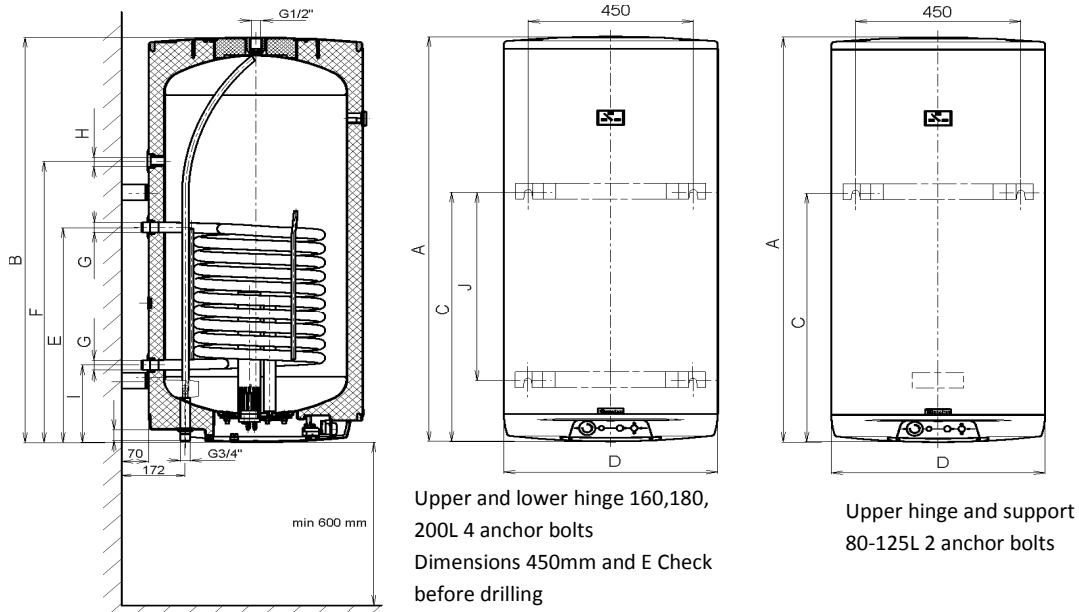

Figure 1

TYPE	OKC 80	OKC 100	OKC 125	OKC 160	OKC 180	OKC 200
		OKC 100/1m ²	OKC 125/1m ²	OKC 160/1m ²	OKC 180/1m ²	OKC 200/1m ²
A	736	881	1046	1235	1187	1287
B*	731	876	1041	1230	1182	1282
C	615	765/636	765/801	1005	793	793
D	524	524	524	524	584	584
E	501	651/701	651/701	651/701	685	685
F	-	- / 551	- / 551	- / 831	- / 895	- / 895
G	G3/4"	G3/4" / G1"	G3/4" / G1"	G3/4" / G1"	G3/4" / G1"	G3/4" / G1"
H	-	- / G3/4"	- / G3/4"	- / G3/4"	- / G3/4"	- / G3/4"
I	211	211	211 / 261	211/261	245	245
J	-	-	-	720/815	600	600

*Distance from the upper heater's edge to the end of the water inlet and outlet tubes. Check the B and N dimensions before drilling. The values behind the slash apply to heaters with a 1.08 m² exchanger.

Table 3

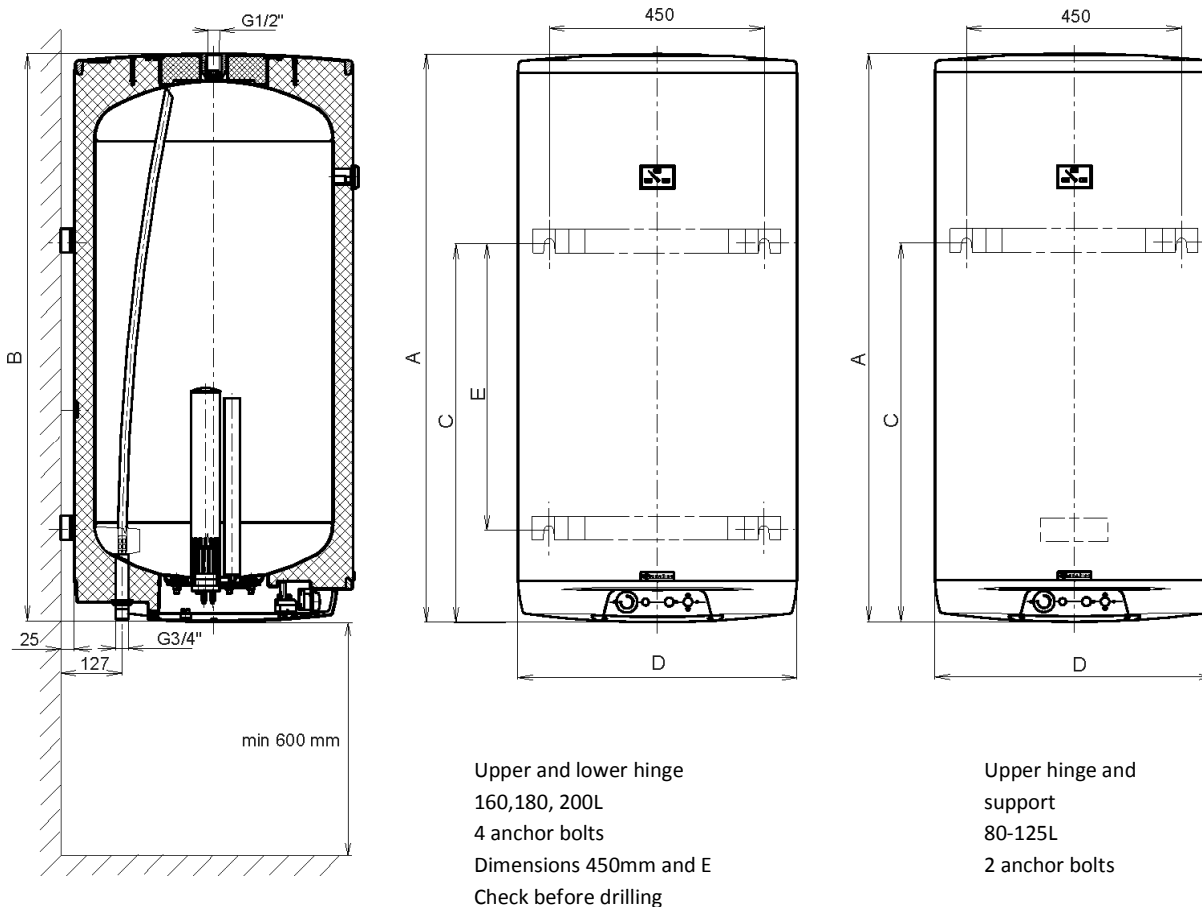

Figure 2

TYP	OKCE 80	OKCE 100	OKCE 125	OKCE 160	OKCE 180	OKCE 200
A	736	881	1046	1235	1187	1287
B*	731	876	1041	1230	1182	1282
C	615	765	765	1005	793	793
D	524	524	524	524	584	584
E	-	-	-	720	600	600

*Distance from the upper heater's edge to the end of the water inlet and outlet tubes.

Table 4

2 OPERATION AND FITTING INSTRUCTIONS

2.1 OPERATING CONDITIONS



The tank shall only be used in accordance with the conditions specified on the performance plate and in instructions for electric wiring. Besides legally acknowledged national regulations and standards, also conditions for connection defined in local electric and water works have to be adhered to, as well as the installation and operation manual. The room, in which the appliance will be operated, must be frost-free. The appliance has to be mounted at a convenient place, it means that the appliance must be easily available for potential necessary maintenance, repair or replacement, as the case may be.

We would like to emphasise that the heater must not be connected to power supply if work involving flammable liquids (petrol, spot remover) or gases, etc., is performed nearby.



If water is strongly calcareous we recommend that any of the common decalcifying devices was installed with the appliance, or the thermostat to be set to minimum operation temperature of 60°C. For proper operation, drinkable water of adequate quality shall be used. To avoid potential sediments we recommend that the device was installed together with a water filter.

2.2 WALL MOUNTING



Prior to mounting, check the loading capacity of the wall and, depending on the type of masonry, choose a suitable anchorage material, or reinforce the wall, if needed. The water heater shall only be mounted in vertical position so that the lower side of the heater was placed at least 600 mm above the floor (Figure 3). In combined heaters, elbows have to be attached to the heating water inlet and outlet and, by turning them, the mounting either from the right or from the left has to be determined. With regard to various types of carrying masonry and broad assortment of special anchorage material available at the market, we do not **provide** heaters with this material. The anchorage system has to be selected individually, depending on the conditions. We recommend an **authorised company** perform **mounting on the wall** and anchorage, or discuss the **anchorage with a professional**.



If the hot water heater is mounted in a **tight, small space**, or in an intermediate ceiling, etc., you have to make sure that the connecting side of the appliance (connections to water supply, area for electric plugging) remained accessible and no heat accumulation occurs. Free space of up to **600 mm** from the bottom edge of the heater has to be available under the heater.

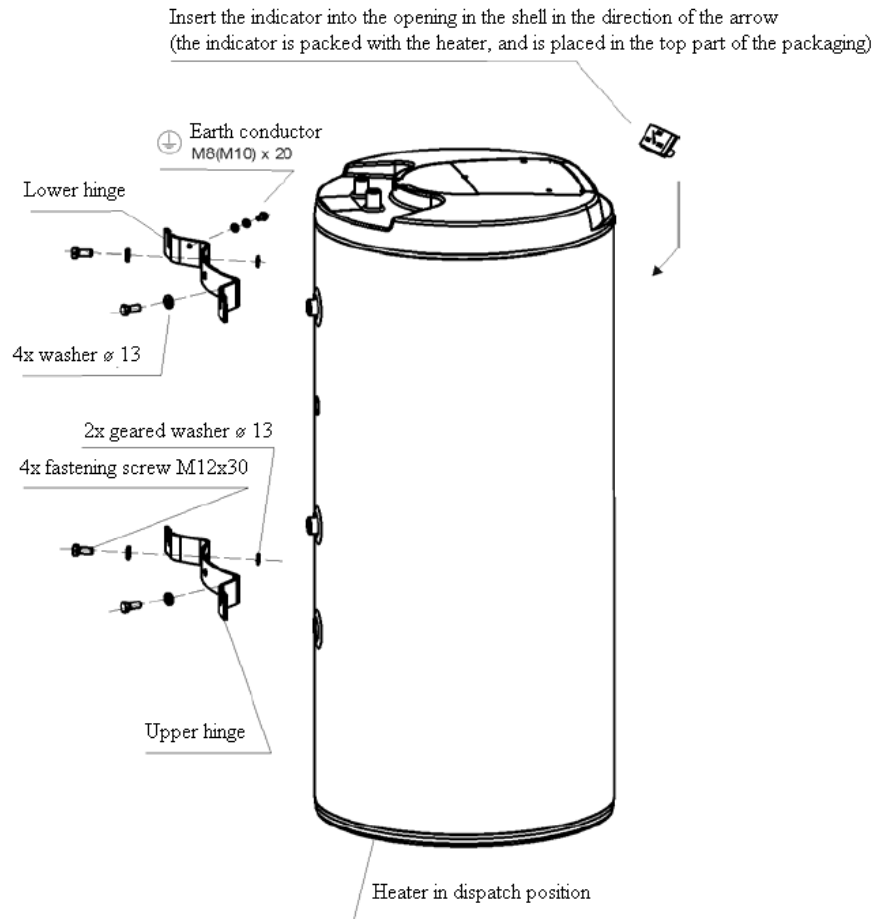

Figure 3

2.3 PLUMBING FIXTURE



Connection of heaters to plumbing fixtures is illustrated on Figure 4. For potential disconnection of the heater, the service water inlets and outlets must be provided with screw coupling Js 3/4". Safety valve is mounted on the cold water inlet identified with a blue ring.



Each hot service water pressure heater must have a membrane spring loaded with a safety valve. Nominal clearance of safety valves is defined in the standards. The heaters are not equipped with a safety valve. The safety valve must be easily accessible, as close to the heater as possible. The input pipes must have at least the same clearance as the safety valve. The safety valve is placed high enough to secure dripping water drain by gravity. We recommend mounting the safety valve onto a branch pipe. This allows easier exchange without having to drain the water from the heater. Safety valves with fixed pressure settings from the manufacturer are used for the assembly. Starting pressure of a safety valve must be identical to the maximum allowed heater pressure, and at least 20% higher than the maximum pressure in the water main (Table 5). If the water main pressure exceeds such value, a reduction valve must be added to the system. No stop valves can be put between

the heater and the safety valve. During the assembly, follow the guide provided by the safety equipment manufacturer.



It is necessary to check the safety valve each time before putting it into operation. It is checked by manual moving of the membrane from the seat, turning the make-and-break device button always to the right. After being turned, the button must click back into a notch. Proper function of the make-and-break device results in water draining through the safety valve outlet pipe. In common operation, such a check needs to be implemented at least once a month, and after each heater shutdown for more than 5 days. Water may be dripping off the drain pipe of the safety valve; the pipe must be open into the air, pointed down; environment temperatures must not drop below zero. When draining the heater, use a recommended drain valve. First, close water input into the heater. Find necessary pressure values in the following table. For proper safety valve operation, a backflow valve must be mounted on the inlet pipes, preventing spontaneous heater draining and hot water penetrating back into the water main. We recommend that the hot water distribution from the heater was as short as possible to minimise heat losses.



We recommend that the hot water distribution from the heater was as short as possible to minimise heat losses.

Required pressures:

SAFETY VALVE STARTING PRESSURE [MPa]	ADMISSIBLE OPERATING OVER-PRESSURE OF WATER HEATER [MPa]	MAXIMUM PRESSURE IN COLD WATER PIPES [MPa]
0.6	0.6	up to 0.48
0.7	0.7	up to 0.56
1	1	up to 0.8

Table 5

Heaters must be provided with a discharge valve mounted on the cold service water inlet to the heater for potential disassembly or repair. **When assembling the security equipment, follow Standards.**

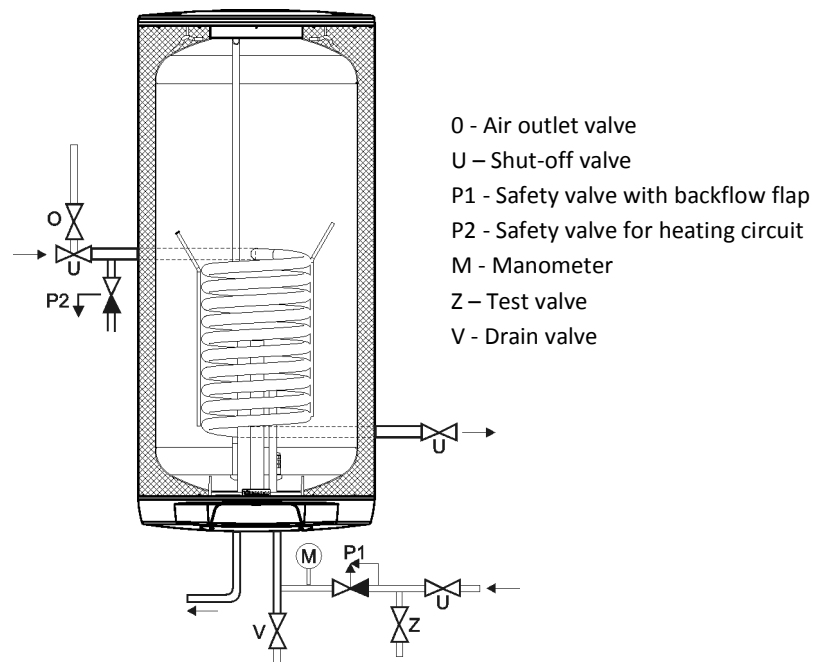

Figure 4

2.4 ELECTRIC WIRING

2.4.1 ELECTRIC INSTALLATION GENERAL INFORMATION



- The electric wiring scheme is attached to the water heater on the side of the electric installation guard (see also Figure 5).
- Connection, repairs, and wiring inspections may only be implemented by a company (person) authorised to such activity.
- Expert connection must be confirmed on the warranty certificate.
- The heater is connected to the 400 V/50 Hz electric network using a fixed moving conductor with a switch that turns off all network poles and the circuit breaker (protector).
- The degree of protection of electric parts of the heater is IP 45.
- Respect the rules of protection against electrical injuries in accordance with Standards.

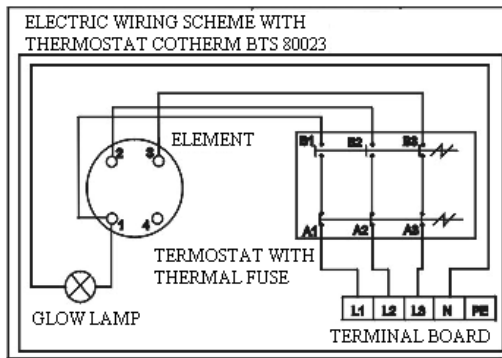

Figure 5

2.5 CONNECTION OF INDIRECT HEATER TO HOT WATER HEATING SYSTEM



It is recommended to install stop valves on the heating water inlet and outlet (for possible dismantling of the heater). The valves have to be as close to the heater as possible to avoid higher thermal losses (Figure 6).

TANK TYPE COMBINED WATER HEATER; HOT WATER DISTRIBUTION

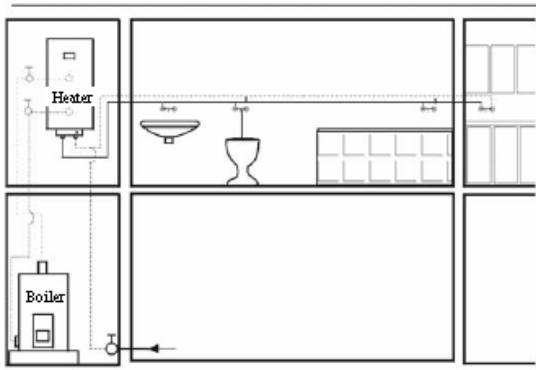

TANK TYPE ELECTRIC WATER HEATER; HOT WATER DISTRIBUTION

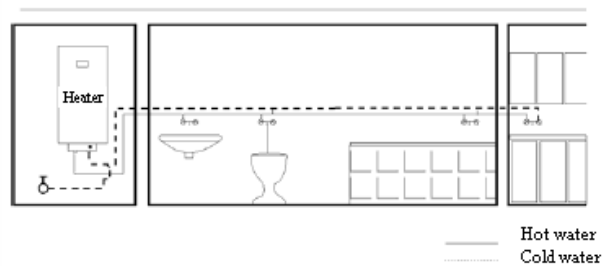

— Hot water
 - - - Cold water
 ····· Heating circuit
 ——— Return circuit

— Hot water
 - - - Cold water

Figure 6

2.6 FIRST HEATER COMMISSIONING



After connecting the heater to the water supply, the hot water heating system, the electric network, and after testing its safety valve (based on the valve manual attached), the heater may be put into operation. Before opening the power supply, the tank must be filled with water. The process of first heating must be executed by licensed professional who has to check it. Both the hot water outlet pipe and safety armature parts may be hot.



During the heating process the pressurised connection water that increases its volume due to heating must drip off the safety valve. In non-pressurised connection water drips off the overflow combination faucet. When heating is finished, the set temperature and the actual temperature of consumed water should be roughly equal. After connecting the heater to the water main and electrical power system, and after checking the safety valve (following the instructions attached to the valve), the heater can be put into operation.

Procedure of putting the heater into operation:

1. Check both water and electric installation; for combined heaters, check the installation to a hot water heating system. Check proper placement of operating and safety thermostat sensors. The sensors must be inserted all the way in; first the operating and then the safety thermostat.
2. Open the hot water valve on the combination faucet.
3. Open the cold water inlet valve to the heater.
4. As soon as the water starts running through the hot water valve, the heater is filled and the valve can be closed.
5. In case of a leakage (flange lid), we recommend fastening the flange lid bolts.
6. Fasten the electric installation cover.
7. In case of service water heating by electric energy, turn on the electricity (for combined heaters, the heating water valve at the heating water entry to heating insert must be closed).
8. When heating service water with electric energy from the hot water heating system, turn the electricity off and open the valves of heating water input and output, possibly de-aerate the exchanger.
9. When commencing operation, flush the heater until the cloudiness in the water is gone.
10. Make sure to fill in properly the warranty certificate.

2.7 PUTTING OUT OF SERVICE, DISCHARGE



If the hot water heater is put out of service for a longer time, or if it is not going to be used it has to be drained and disconnected from the electric supply network on all poles. The switch for the supply lead or the fuse cut-outs have to be shut off.

At places with permanent risk of frost the hot water heater must be drained before the cold season starts if the appliance remains out of service for several days and if the power supply is disconnected.



Drainage of service water shall be performed after closing the shut-off valve in the cold water supply piping (through the discharge valve for safety valve combination), and with simultaneous opening of all hot water valves of connected fittings. **Hot water may outflow during the drainage!** If there is a risk of frost it has to be considered that not only the water in the hot water heater and in the hot water piping may get frozen but also the water in the entire cold water supply piping. It is therefore advisable to drain all fittings and piping that carry water, up to the part where the house water meter is installed (connection of the house to water main) which is not jeopardised by frost. When the tank is to be used again, it has to be filled with water and one needs to make sure that the water **flowing out at the hot water valves did not contain any bubbles.**

2.8 INSPECTION, MAINTENANCE & CARE FOR THE APPLIANCE



During the heating process the water that increases its volume during the heating must drip off the safety valve outlet (in non-pressurised connection this water drips off the combination faucet valve). In full heating (about 65°C) the volumetric water gain is approx. 3% of the tank capacity. The function of the safety valve has to be checked regularly (based on the information contained in the attached safety valve manual). In common operation, such a check needs to be implemented at least once a month, and after each heater shutdown that exceeds 5 days.

Caution! In doing so, the cold water supply pipe and the connection fitting of the tank may get heated! If the hot water heater does not work, or if hot water is not withdrawn, no water shall drip off the safety valve. If water drips, then the pressure in the supply piping is either too high, or the safety valve is defective. Please call a specialised plumber immediately!



If water contains too many minerals, an expert has to come to remove the scale that forms inside the tank, as well as free sediments. Repetitive water heating causes limestone sediment on both the tank walls and chiefly the flange lid. The sedimentation depends on the hardness of water heated, its temperature, and amount of hot water consumed.

We recommend checking and cleaning the tank from scale and eventual replacement of the anode rod after two years of operation. The anode life is theoretically calculated for two years of operation; however, it changes with water hardness and chemical composition in the place of use. Based on such an inspection, the next term of anode rod exchange may be determined. Have the company in charge of service affairs clean and exchange the anode.

When discharging water from the heater, the combination faucet valve for hot water must be open in order to avoid creating under pressure that would prevent water discharge. This has to be performed after one or two years of operation. The cleaning is carried out through the hole in the flange by: draining the boiler, dismantling the flange lid and cleaning the tank. A new sealing has to be used for re-fitting. Since the inside of the heater has special enamel, the surface of which must not get in contact with a scale removing agent – do not work with a lime pump. Remove the lime layer with a timber and suck it off, or wipe it off with a clout. After that, the appliance must be rinsed thoroughly and the heating process is checked the same as during the initial putting in operation. Do not use any abrasive cleaning agents or dye thinners to clean the outer shell of the heater (such as cellulose thinner, trichlor, and the like). For cleaning use a wet clout and add a few drops of liquid cleaning agent for household applications.

2.9 MOST FREQUENT FUNCTION FAILURES AND THEIR CAUSES

Potential failures – Table 6

FAILURE SYMPTOM	LED	SOLUTION
Water is cold	<ul style="list-style-type: none"> • LED is on 	<ul style="list-style-type: none"> • the temperature set on the thermostat is too low • heating element failure
Water is cold	<ul style="list-style-type: none"> • LED is not on 	<ul style="list-style-type: none"> • no supply voltage • thermostat failure • safety thermostat shut off probably due to failed operation thermostat
Water is not warm enough	<ul style="list-style-type: none"> • LED is on 	<ul style="list-style-type: none"> • failure of one of the coils in the element (contains 2)
Temperature of water is not corresponding		<ul style="list-style-type: none"> • defective thermostat
Water is constantly dripping of the safety valve	<ul style="list-style-type: none"> • LED is not on 	<ul style="list-style-type: none"> • input pressure too high • faulty safety valve

Table 6



Do not try to repair the failure yourselves. Seek either expert or service help. It does not take much for an expert to remove the defect. When making a repair appointment, report the type and serial number you find on the performance plate of your water heater.

3. OPERATION OF THERMOSTAT

3.1 OPERATING MODES

3.1.1 SERVICING

Service devices of heaters of 80 to 200 l capacity are located under the transparent guard of the control panel. (Figure 7).

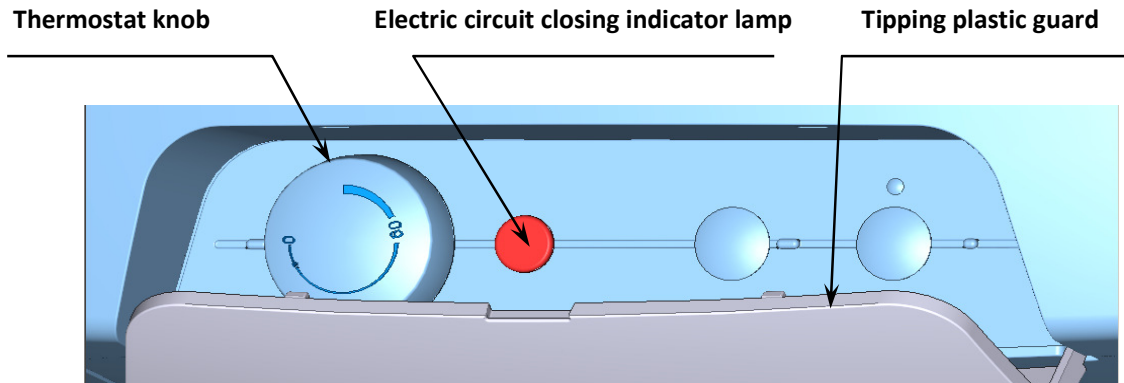

Figure 7

3.1.2 TEMPERATURE SETTING

Water temperature is set by turning the thermostat knob. The desired symbol is adjusted against the fixed point on the control panel - Figure 8.

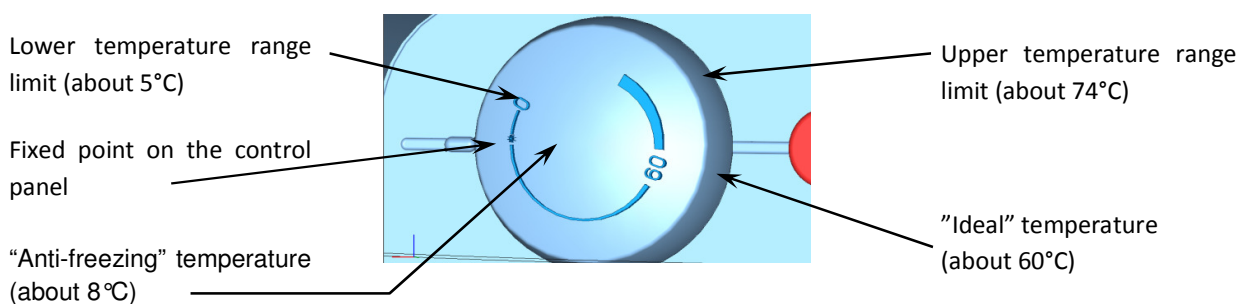

Figure 8



Adjusting the thermostat selector at the left backstop does not mean permanent shutoff of the heating element. When the heater is in use without blocking the daily rate, we do not recommend the temperature to be set above 65°C. The maximum value to select is “60”.

3.1.3 LIMITING THE REGULATION RANGE; LOCKED SETTINGS

For various safety reasons (unintentional scalding, preventing children or unauthorised person from handling), the regulation range can be **limited**, or the setting on the thermostat **blocked** (Figure 9).

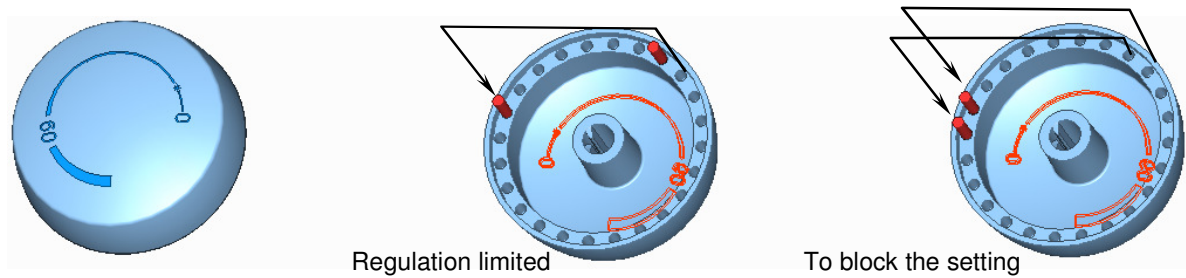

Figure 9

To limit regulation

- off the thermostat knob (it will be tough at first) and you will find two cylindrical pins $\varnothing 2,15\text{mm}$ on the back side of the knob,
- pull off one pin and insert it to the corresponding hole of the selected maximum temperature,
- put the knob back on (to the stop).

To block the setting

- set the selected temperature pull off the thermostat knob without changing the setting, there are two pins on the back side of the knob,
- pull off both of them and fit them to the holes corresponding with the selected temperature so that the gap between the pins was without a hole, and the position was opposite the set temperature.

4 IMPORTANT NOTICES

4.1 INSTALLATION REGULATIONS

- **Without a confirmation of performed electrical installation issued by an authorised company, the warranty certificate shall be void.**
- Check and exchange the Mg anode regularly.
- You have to apply for approval of a local power supplier to connect the heater.
- **No stop valves can be put between the heater and the safety valve.**
- If the overpressure in the water main exceeds 0.6 MPa, a pressure control valve must be mounted before the safety valve.
- All hot water outputs must have a combination faucet.
- Before filling the heater with water for the first time, it is recommended to fasten the flange connection nuts of the tank.
- It is not allowed to handle the thermostat, aside from temperature resetting with a control button.

- All electric installation handling, adjustment and replacement of the regulation elements shall only be performed by an authorised service company.
- **The thermal fuse must not be turned off!** In case of thermostat defect, the thermal fuse interrupts electric power input to the heating element if the water temperature in the heater exceeds 90 °C.
- As an exception, the thermal fuse may also switch off due to water overheating caused by overheating the hot water heating system boiler (in case of a combined heater).
- **We recommend you operate the heater with one type of energy.**



Both the electric and water installation must follow and meet the requirements and regulations relevant in the country of use!

4.2 DISPOSAL OF PACKAGING MATERIAL AND FUNCTIONLESS PRODUCT

A service fee for providing return and recovery of packaging material has been paid for the packaging in which the water heater was delivered. The service fee was paid pursuant to Act No 477/2001 Coll., as amended, at EKO-KOM a.s. The client number of the company is F06020274. Take the water boiler packages to a waste disposal place determined by the town. When the operation terminates, disassemble and transport the discarded and unserviceable heater to a waste recycling centre (collecting yard), or contact the manufacturer.



3 PRODUCT ACCESSORIES

The product is supplied with a safety valve, 2 – 4 fastening screws M 12x30, 2-4 washers ϕ 13 (OKCE version has them mounted in the hinges on the heater) and a thermometer. The above parts are packed and placed in the packaging in the top part of the heater.

It is in your own interest to check the completeness of the accessories.

7-2013